

Design Information Fact Sheet

RadHard LVDS Family

Drivers, Receivers, Serializer, Deserializer, Repeater, Crosspoint Switch

Low-Voltage Differential Signaling (LVDS) technology is an excellent solution for spaceborne applications that need to move large amounts of data quickly between systems or components. Using current 0.25 μ m CMOS technology, LVDS can be used to achieve a radiation-hardened solution for transferring information at data rates in excess of one Gigabit/second with low noise, lower power, and robust transmission signals.



- ❑ UT54LVDS031 5-volt Quad Driver
- ❑ UT54LVDS031 5-volt Quad Driver
- ❑ UT54LVDS031LV 3.3-volt Quad Driver
- ❑ UT54LVDM031LV Low-voltage Bus - LVDS Quad Driver
- ❑ UT54LVDS032 5-Volt Quad Receiver
- ❑ UT54LVDS032S 5-Volt Quad Receiver with Cold Spare
- ❑ UT54LVDS032LV 3.3-volt Quad Receiver
- ❑ UT54LVDS032LVT Low-Voltage Quad Receivers with Integrated Termination Resistor
- ❑ UT54LVDM055LV Dual Driver and Receiver
- ❑ UT54LVDS217 Serializer 3.3-volt
- ❑ UT54LVDS218 Deserializer 3.3-volt
- ❑ UT54LVDM328 Octal 400 Mbps Bus LVDS Repeater
- ❑ UT54LVDM228 Quad 2x2 400 Mbps Crosspoint Switch

Typically LVDS interconnect links have a different impedance of 100. It is recommended to use cables and connectors that have differentially matched impedance; this minimizes impedance discontinuities. Twisted-pair cables offer the best signal integrity and generate less EMI due to the magnetic field canceling effects of using balanced transmission lines. LVDS supports interconnect lengths of up to 10 meters.

RadHard LVDS Driver/Receiver Design Examples

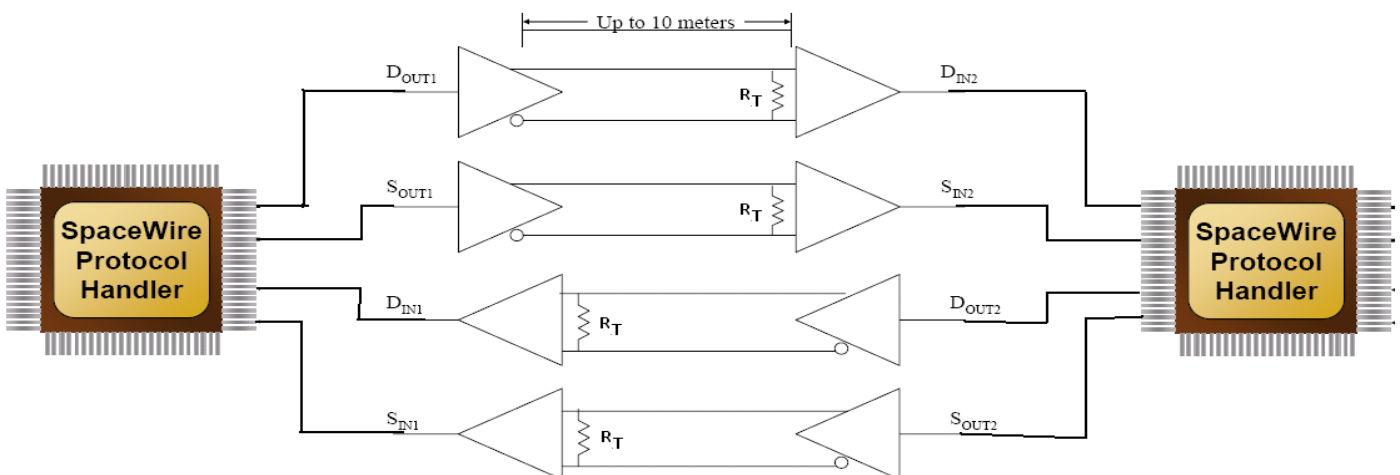
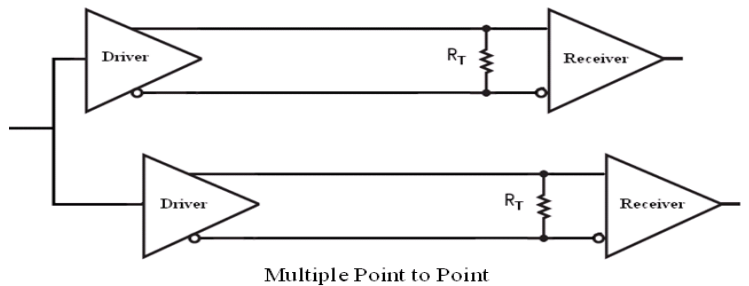
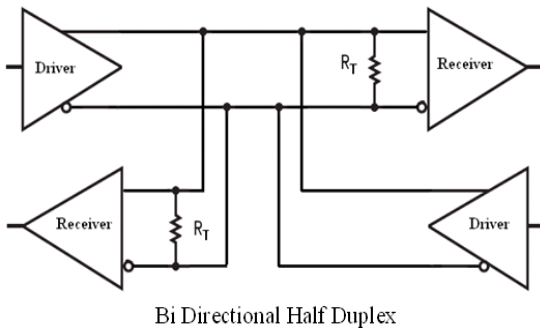
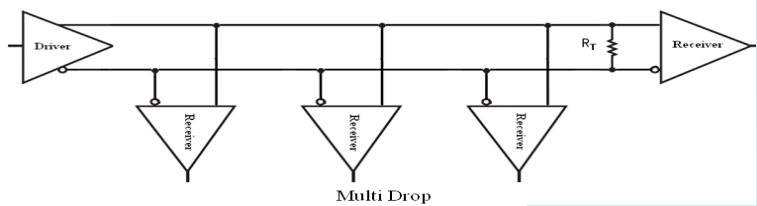
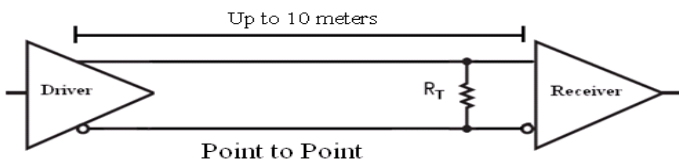

SpaceWire point-to-point configuration using LVDS. Diagram shows one SpaceWire Link

RadHard LVDS Serializer/Deserializer Design Examples

The serializer converts 7 bits of parallel data to a single LVDS serial data link. The deserializer receives the LVDS data transmitted from the serializer and converts it back into the original 7 bits of parallel data. The serializer is a parallel-to-serial converter and the deserializer is a serial-to-parallel converter. One of the main advantages of the serializing data is skew prevention. Skew is an inherent problem with sending parallel data and its clock across cables or Printed Circuit Boards (PCB) traces. Data and clock recovery are used by the deserializer to extract the serialized data and clock and turn it back into parallel data. Transmitting serial data as opposed to parallel data also reduces the number of interconnect cables or traces required. Thus, reducing space needed for interconnect.

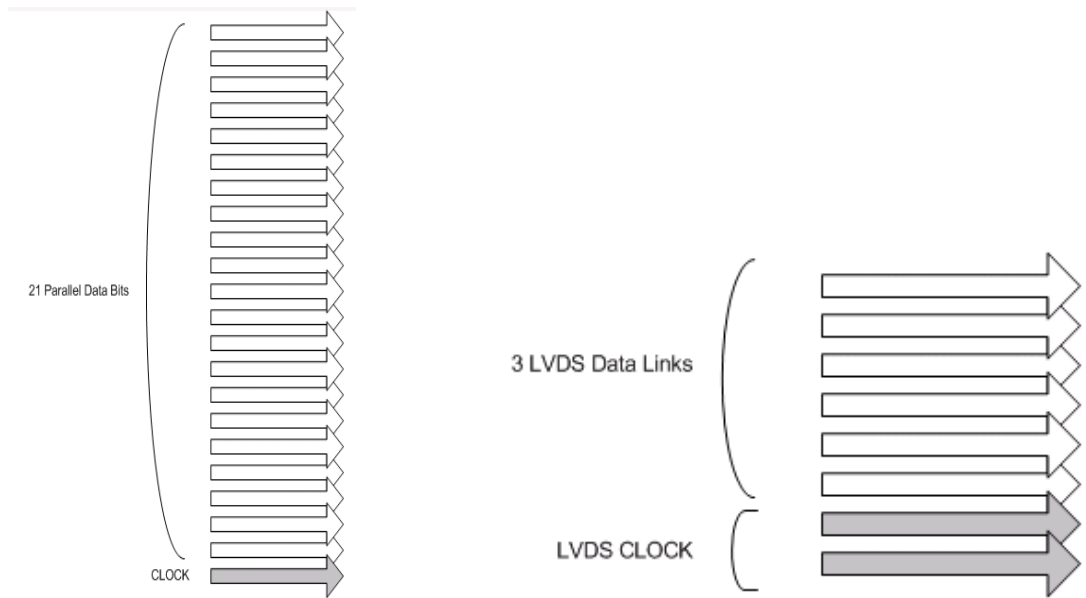

**21 bits of parallel data can be serialized and transmitted over 6 wires.
(a 71% reduction in number of wires required to transmit the data)**

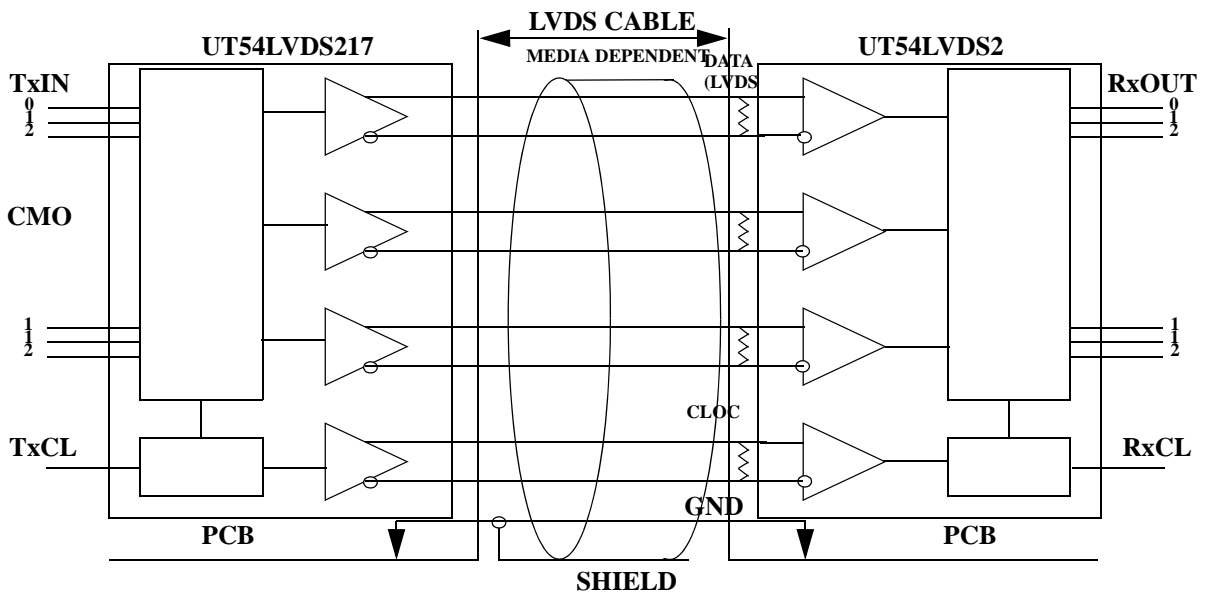

RadHard LVDS Bus Repeater/Crosspoint Switch Design Examples

The UT54LVDM328 is a repeater designed specifically for bridging multiple backplanes in a system. The UT54LVDM328 repeats signals between backplanes and accepts or drives signals onto the local bus.

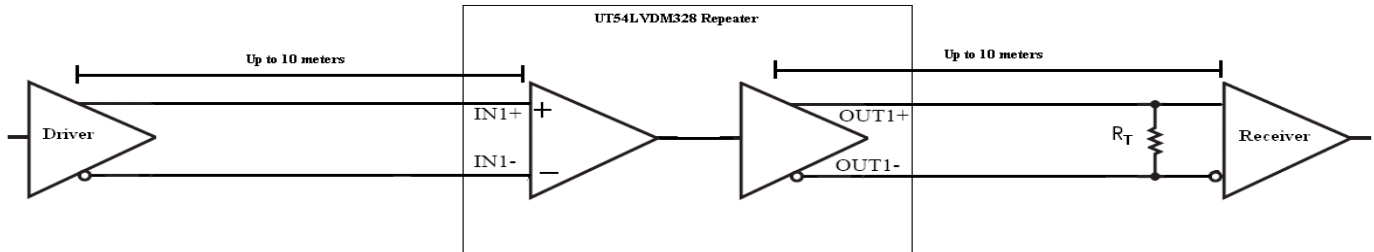

The Bus Repeater can be used to extend the distance an LVDS signal can travel.

The UT54LVDM228 is a quad 2x2 Crosspoint Switch that has fully differential data paths from input to output for low noise generation and low pulse with distortion. The non-blocking design allows connection of any input to any output or outputs on each switch. This device can be used as a high-speed differential crosspoint, 2:1 mux, 1:2 demux, repeater or 1:2 signal splitter. The mux and demux functions are useful for switching between primary and backup circuits in fault tolerant systems.

Crosspoint switches can have the following four configurations per Truth Table:

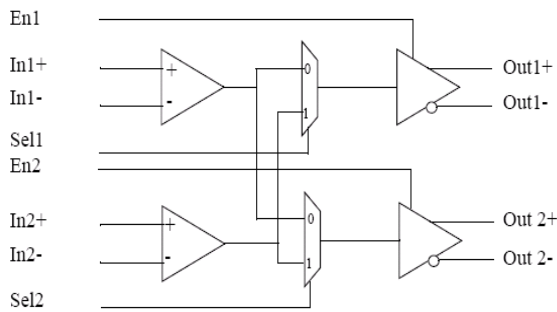

TRUTH TABLE

Sel1	Sel2	Out1	Out2	Mode
0	0	In1	In1	1:2 splitter
0	1	In1	In2	Repeater
1	0	In2	In1	Switch
1	1	In2	In2	1:2 splitter

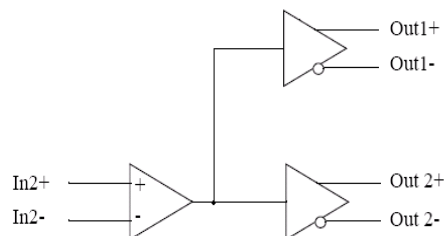
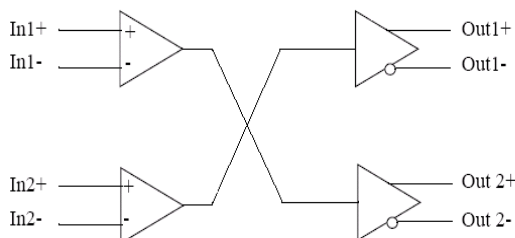
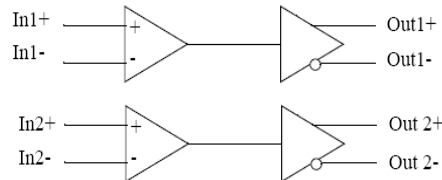
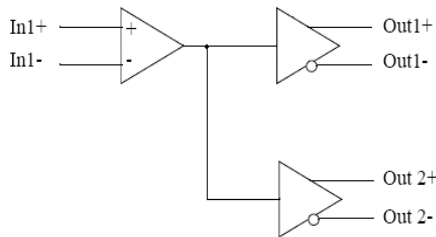

Internet Resources:

Visit www.aeroflex.com/LVDS to download:

- LVDS and Evaluation Board Data Sheets
- Applications Notes
- IBIS Models

Visit www.aeroflex.com/RadHard to see the latest
Aeroflex Colorado Springs' RadHard products for space applications!



COLORADO

Toll Free: 800-645-8862
Fax: 719-594-8468

INTERNATIONAL

Tel: 805-778-9229
Fax: 805-778-1980

NORTHEAST

Tel: 603-888-3975
Fax: 603-888-4585

SE AND MID-ATLANTIC

Tel: 321-951-4164
Fax: 321-951-4254

WEST COAST

Tel: 949-362-2260
Fax: 949-362-2266

CENTRAL

Tel: 719-594-8017
Fax: 719-594-8468

www.aeroflex.com info-ams@aeroflex.com

Aeroflex Colorado Springs, Inc., reserves the right to make changes to any products and services herein at any time without notice. Consult Aeroflex or an authorized sales representative to verify that the information in this data sheet is current before using this product. Aeroflex does not assume any responsibility or liability arising out of the application or use of any product or service described herein, except as expressly agreed to in writing by Aeroflex; nor does the purchase, lease, or use of a product or service from Aeroflex convey a license under any patent rights, copyrights, trademark rights, or any other of the intellectual rights of Aeroflex or of third parties.



Our passion for performance is defined by three
attributes represented by these three icons:
solution-minded, performance-driven and customer-focused